



ALC Sentinel

4 channel class-D
amplified loudspeaker controller

user's manual



Featured models:
Sentinel3
Sentinel10

evolutionary audio solutions™

Table of contents

1	Introduction	3
2	Important safety instructions	6
3	Precautions	7
4	Installation	8
5	Overview	11
6	Connections	14
7	Operation	17
	7.1 Tab section Overview	19
	7.2 Tab section Gain	21
	7.3 Tab section Eq	23
	7.4 Tab section Delay	25
	7.5 Tab section Presets	26
	7.6 Tab section Routing	28
	7.7 Tab section System	29
	7.7.1 Speaker	29
	7.7.2 Amp	29
	7.7.3 Setup	30
	7.7.4 Oplog	33
	7.7.5 Firmware	34
	7.7.6 Project	34
	7.7.7 Network	35
	7.8 Remote control through a VNC client	36
	7.8.1 Remote control with the Virtual Encoder™	37
8	Safety	36
9	Service and support	37
10	Specifications	40
11	Block diagram	42
12	Block diagram Bridge mode – ALC Sentinel 3 only	43
13	CE declaration of conformity	44



1. Introduction

Dear customer,

Congratulations on your purchase of an Alcons Audio ALC Sentinel amplified loudspeaker controller, and thank you for your confidence in Alcons products. We are very honoured to welcome you to the growing family of Alcons ambassadors!

For your safety, please read the Important safety instructions and the Precautions section before installing and operating the amplifier.

The “engine” behind every Alcons sound system is the Amplified Loudspeaker Controller. The ALC is a combination of a loudspeaker controller and a very high efficiency power amplifier. The Sentinel range sets new standards in sound quality, by bringing Alcons famous pro-ribbon sound into the digital amplification domain, while increasing system performance to the highest levels.

The ALC Sentinel is proprietary designed and developed by Alcons Audio and features a powerful 4-channel DSP-based controller with patented Class-D amplifier stages onboard.

Main focus in the development of the Sentinel range was to obtain a very low distortion “audiophile-grade” signal drive and a surplus of headroom under any circumstance, to get the absolute maximum performance out of the Alcons sound systems.

Speakon® and PowerCon® are trademarks of Neutrik® AG.

ALC Sentinel features

Fully-intuitive control and feedback

The Sentinel features on-unit control over the complete amplifier and processor sections through a 4.3” (480 x 272 pixels) touch screen TFT-LCD display and a multi-colour LED-illuminated rotary encoder. A dedicated micro-computer “oversees” and controls all processes; Through the internal I²C communication network, all parameters of DSP, amplifier stages, power-supplies and micro-controllers can be monitored and guided, for maximum operating efficiency and full status/application logging.

Compact and light weight

The combination of Class-D designed amplifier stages, switch-mode power supplies and specific focus on a weight and space-saving structure, brings a highly efficient power-to-size/weight ratio.



1. Introduction

4 x 4 Input / Output matrix

With 4 individual inputs, a free-configurable input / output matrix is formed. Each channel offers a choice of up to 4 inputs, incl. input-summing, with selectable analogue or digital (AES3) input signals.

Audiophile signal processing

The internal D/A conversion accepts signals of up to 192kHz, with other sample rates from 44.1 kHz being automatically up-/down-sampled to 96kHz processing. In striving for the highest audio quality possible, a fully customized sample rate conversion is implemented. This enables true high-end HiFi sound quality at concert SPL's.

Powerful Drive Processing

The speaker- and signal processing is taken care of by a 450MHz Analog Devices SHARC™ processor (S3: 400MHz). This is one of the most powerful DSP engines available and enables fastest processing of even the most complex (IIR, FIR) algorithms for protection, filtering, power and response optimisation . On-board features include 6-band parametric/shelf/pass-filter EQ. per channel, delay, factory presets for all systems and system configurations.

SIS Signal Integrity Sensing™

SIS is a unique feature installed in all Alcons amplifiers that dynamically senses the signals arriving at the loudspeaker terminals, and so compensating for errors introduced by cable resistance and self-induction. Doing so, SIS™ reduces linear and non-linear distortion, compensates signal loss and maintains high damping figures, thus achieving high signal integrity, regardless of the cable length.

Intelligent power-supply

The power-supply section is controlled by the Power Detection Circuit, that measures the input AC current and protects against high-voltage overload up to 400V. It also features automatic selecting of the correct operating AC current circuit 115V / 230V ("global power supply"). It also features a "redundant setup" with load balancing capabilities. when one SMPS is down, other SMPS automatically takes over for all 4 amp.channels.



1. Introduction

Bridged mono mode - ALC Sentinel 3 only

Bridged mono mode combines the output power of two amplifier channels into one loudspeaker load, resulting in twice the voltage swing and four times the power in a specific load. *See the Connections section!*

Easy servicing and upgrading

The modular design of the complete ALC, caters for easy “in-the-field” servicing and upgrading; The power supplies and amp.stages can be individually exchanged in case of emergency, significantly reducing down-time. The DSP is mounted on a separate PCB, thus can be easily “future-proof” upgraded when required.

The Sentinel3 and Sentinel10 share the same front control panel; When exchanging during servicing, the front control panel automatically detects what model it needs to control; A Sentinel3 or Sentinel10. This saves inventory and guarantees a fast turn-around repair.

Remote-control / Networked audio

The Sentinels are prepared for ALControl™; Alcons Audio’s proprietary, Ethernet-based ALC network . ALControl™ can control individual or clusters of Sentinels, with functions like grouped EQ’ing, event and (on-line) system monitoring and repairs, firmware uploads, a.o. Through two additional RJ45 connectors (redundant) and optional network modules, the Sentinel is prepared for different audio-over-network standards.

Maximum operating reliability

The Sentinels feature most advanced protection circuitries for optimal reliability; Amplifier stage protection against DC, subsonic, RF, short circuit for both speaker signal and sensing signal as well as over-/under voltage; SMPS supplies are protected against over-/under AC voltage. These circuits cut-off operation, when detected.

The dynamic current, voltage and power limiting as well as thermal protection circuits modulate the signal down to safe levels; Together with the redundant-switching between the two SMPS supplies, these modulating safety circuits maintain operation under the most difficult situations.



2. Important safety instructions

Warning: – To reduce the risk of fire or electric shock, do not expose this apparatus to rain or moisture.

1. Read these instructions.
2. Keep these instructions.
3. Heed all warnings.
4. Follow all instructions.
5. Do not use this apparatus near water.
6. Clean only with dry cloth.
7. Do not block any ventilation openings. Install in accordance with the manufacturer's instructions.
8. Do not install near any heat sources such as radiators, heat registers, stoves, or other apparatus that produce heat.
9. Do not defeat the safety purpose of the polarized or grounding-type plug. A polarized plug has two blades with one wider than the other. A grounding type plug has two blades and a third grounding prong. The wide blade or the third prong are provided for your safety. If the provided plug does not fit into your outlet, consult an electrician for replacement of the obsolete outlet.
10. Protect the power cord from being walked on or pinched particularly at plugs, convenience receptacles, and the point where they exit from the apparatus
11. Only use attachments/accessories specified by the manufacturer.
12. Use only with the cart, stand, tripod, bracket or table specified by the manufacturer, or sold with the apparatus. When a cart is used, use caution when moving the cart/apparatus combination to avoid injury from tip-over.
13. Unplug this apparatus during lightning storms or when unused for long periods of time.
14. Refer all servicing to qualified service personnel. Servicing is required when the apparatus has been damaged in any way, such as, the power-supply cord or plug is damaged, liquid has been spilled or objects have fallen into the apparatus, the apparatus has been exposed to rain or moisture, does not operate normally, or has been dropped.



The lightning flash with arrowhead symbol within a triangle, is intended to alert the user to the presence of uninsulated dangerous voltage within the enclosure that may be a risk of electric shock to humans.



The exclamation point within a triangle is intended to alert the user to the presence of important operating instructions in the literature accompanying the product.



3. Precautions

Save the packing material. Should you ever need to ship the amplifier, use only the original packing.

Read this manual carefully before installing and operating your amplifier. Retain this documentation for future reference.

Always operate the amplifier with a grounded AC mains supply. Ensure that the quality of the mains supply is good enough and that it can supply the required peak currents. In addition, proper earthing is necessary to prevent hum and safety problems.

Do not use the amplifier if there is visual damage to the enclosure or cables. Inspect the amplifier and wiring before use. When in doubt, have the amplifier inspected by authorized technical personnel.

Do not make connections to the amplifier while it is switched on. Always shut off the amplifier when making connections to it, and mute the inputs when making connections to preceding equipment in the chain.

Do not spill water or any other liquid to or into the amplifier. Do not operate the amplifier if suspected or standing in liquid. Do not use liquid or aerosol cleaners. Clean only with dry cloth. Leave the amplifier switched-on overnight during multi-day outdoor events, due to night-time air moisture differences. Ensure proper weather protection

Do not block the air intake for the fans on the rear, or the exhaust ports on the front side of the amplifier. The amplifier can run hot, or even go into protect mode if there is insufficient cooling air.

Do not operate the product near any heat source, such as radiators or other devices or expose to direct sunlight. This will affect the temperature headroom.

Make sure that possible dust filters are cleaned frequently. Dirty filters can easily block the flow of air.

Do not remove the cover. There are no user serviceable parts inside the amplifier. Removing the cover exposes you to dangerous voltages inside the amplifier.

Refer servicing to qualified service personnel. Servicing is required when the amplifier has been damaged in any way, liquid has been spilled on or into the amplifier, does not operate normally or has been dropped.

Do not series or parallel connect an amplifier output with any other amplifier output. Connecting outputs together can cause damage to the amplifiers.

Use the mains plug as the disconnecting device. keep it readily accessible. If the mains plug is not readily accessible due to mounting in a 19" rack, then the mains plug for the entire rack must be readily accessible.



4. Installation

Unpacking

Carefully open the shipping carton and inspect the amplifier. Every Alcons amplifier is thoroughly tested and inspected before leaving the factory and should arrive in perfect condition. If you find any damage, notify the shipping company immediately. Only you, the consignee, may initiate a claim for shipping damage. Be sure to save all packing materials for the carrier's inspection.

Please save the packing material. If you ever need to ship the amplifier back to your dealer or the factory, you should only use the original packing.

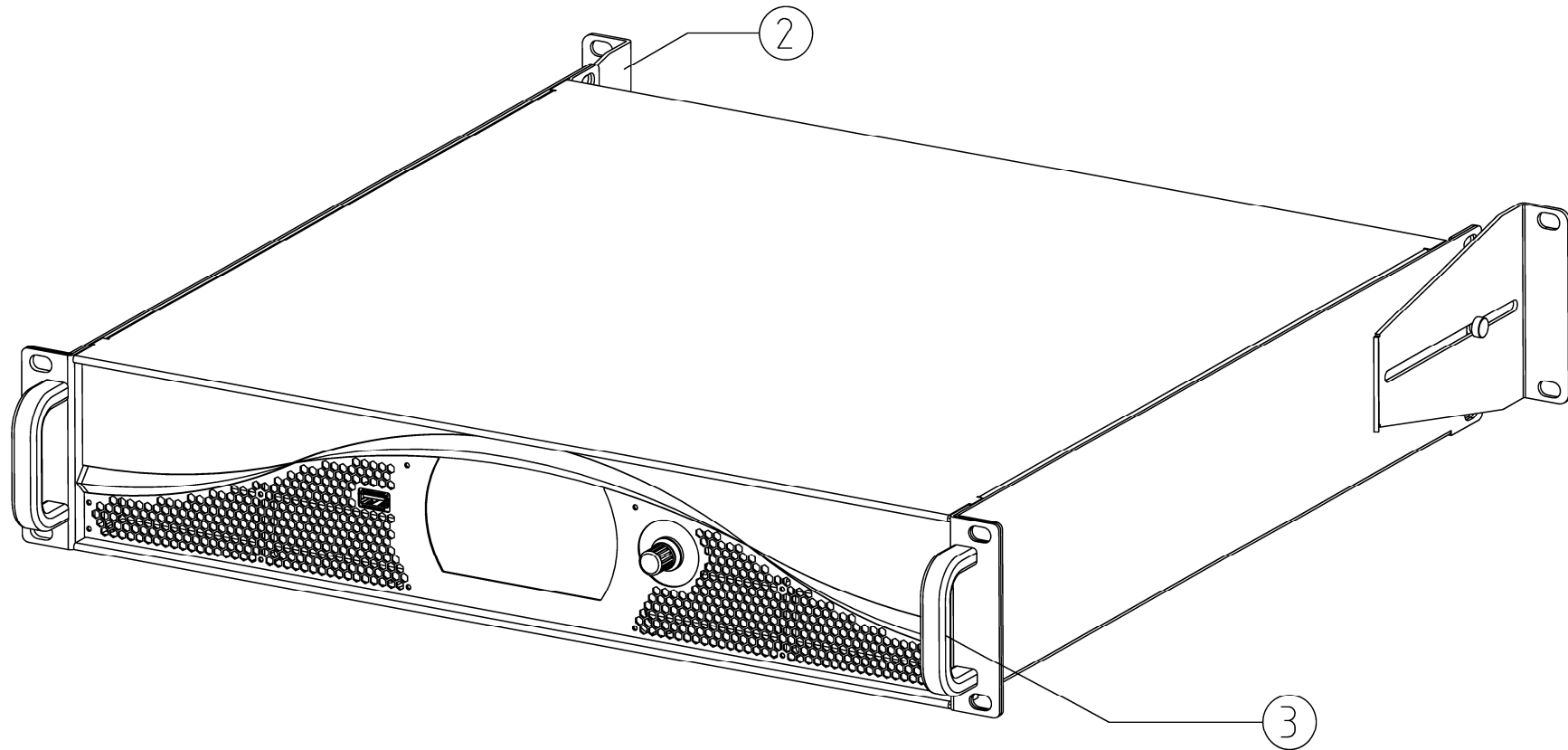

4. Installation

Sentinel parts and dimensions

- 1) Finger guard cooling fans
- 2) SRMB rear rack mounting set
- 3) Rack handle

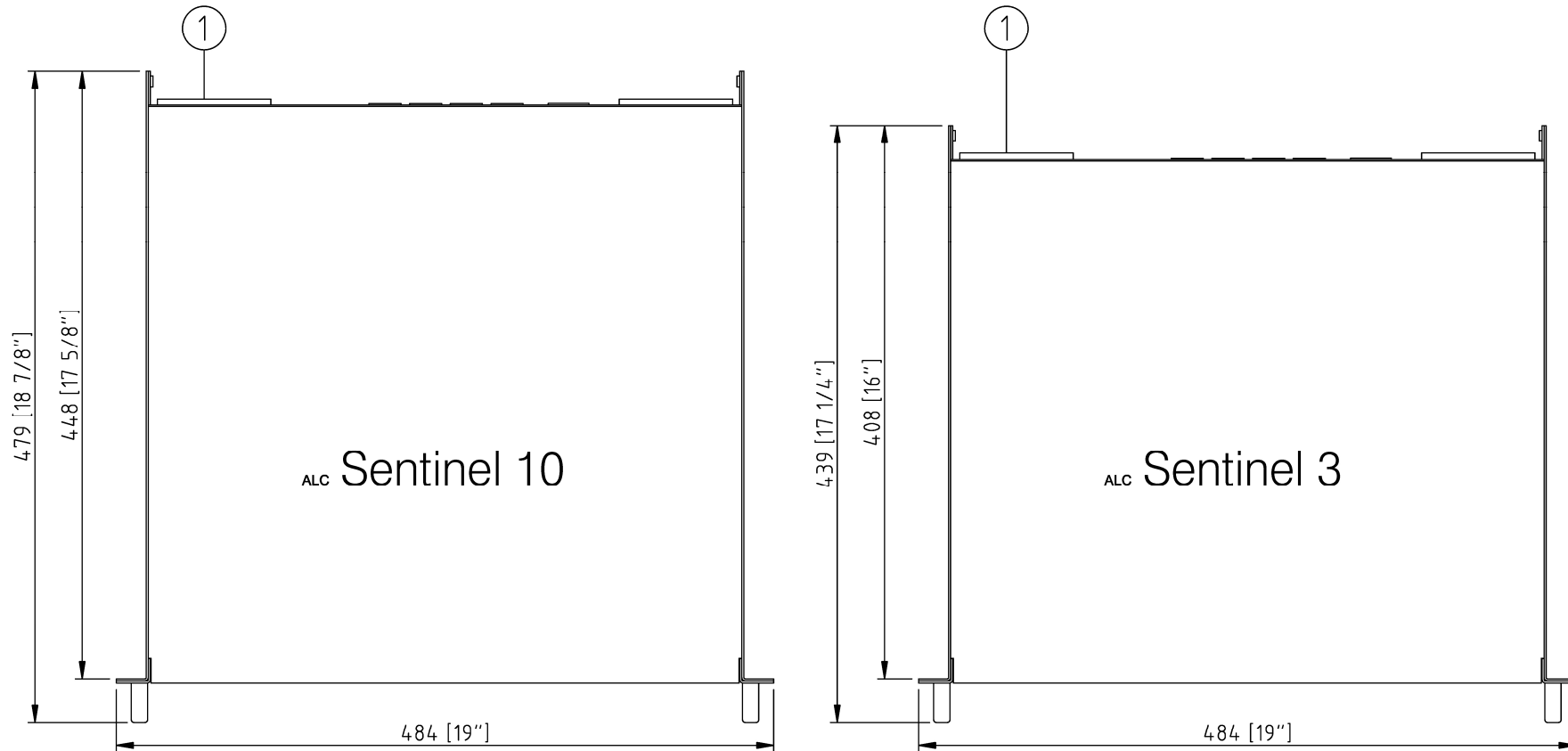

Mounting

The ALC Sentinel amplifiers mount in standard 19-inch racks. A rear mounting set gives additional support. Rear support is highly recommended in all applications, especially with mobile and touring systems. ALC Sentinels can be stacked directly on top of each other. There is no need for spacing between units. Ensure that the bottom ALC Sentinel has a bottom support over the entire depth.



4. Installation

Cooling and ventilation

The ALC Sentinel amplifier uses forced air cooling in order to maintain a low operating temperature. In this device the cooling air enters at the back and the hot air leaves the amplifier at front side. Make sure that there is an adequate supply of fresh, cool air at the back of the amplifier, and that there is sufficient space in the rack for the exhaust air to escape.

Due to the small diameter fans and high turning speed, high noise levels can be encountered.

Do not use ALC 2/ 4 /6 amplifiers (front to side cooling) with Sentinel 3 or 10 amplifiers (rear to front cooling) in one rack.

Mains Power

The AC mains voltage for the ALC Sentinel amplifier is stated at the rear of the amplifier near the PowerCon® input.

Your local power will be detected automatically. For safety reasons you must also ensure that the AC supply is properly grounded. The AC current draw is measured according to the IEC 65 safety standard. The normal operating power is measured using pink noise, with an average power equal to 1/8 of full power. This corresponds to normal music being played to the clip level of the amplifier. The table below shows the AC current draw for different loudspeaker loads.

Make sure your AC power distribution can handle the currents demanded by the amplifiers.

The AC mains power may not deviate more than +/-10% from the nominal values.



Operate the amplifier at a high-range supply (208 to 240 V), if possible.

Only use two (2) Sentinel 3 or one (1) Sentinel 10 per 16A mains outlet for optimal performance. It is possible to use multiple ALC Sentinel 3 or 10 amplified loudspeaker controllers in “low power” applications. Due to the high inrush current, it is advised to switch on a maximum of two units at the same time.

Sentinel 3	Peak output power/channel	1/8 th output power(-9dB):	BTU / W
8 Ω	400 W	536 W	1224 / 359
4 Ω	750 W	788 W	1494 / 438

Sentinel 10	Peak output power/channel	1/8 th output power(-9dB):	BTU / W
8 Ω	1250 W	1328 W	2244 / 658
4 Ω	2500 W	2057 W	3015 / 884

5. Overview

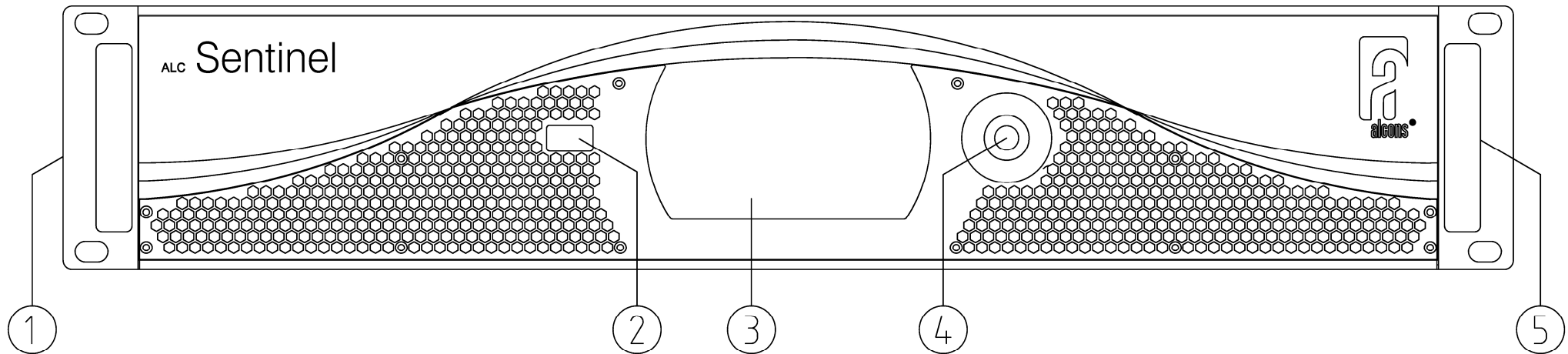

Front panel

- | | |
|------------------|---|
| 1) Mounting ears | 19" rack mounting |
| 2) USB port | USB Host A port – for all USB storage devices |
| 3) TFT Display | Full Colour display with touch screen* |
| 4) Encoder | Multi Colour Encoder |
| 5) Rack handle | Use both handles for manual transportation |

* The touch screen incorporates a thin flexible sheet that may be damaged by sharp objects or heavy treatment.



5. Overview

Rear panel

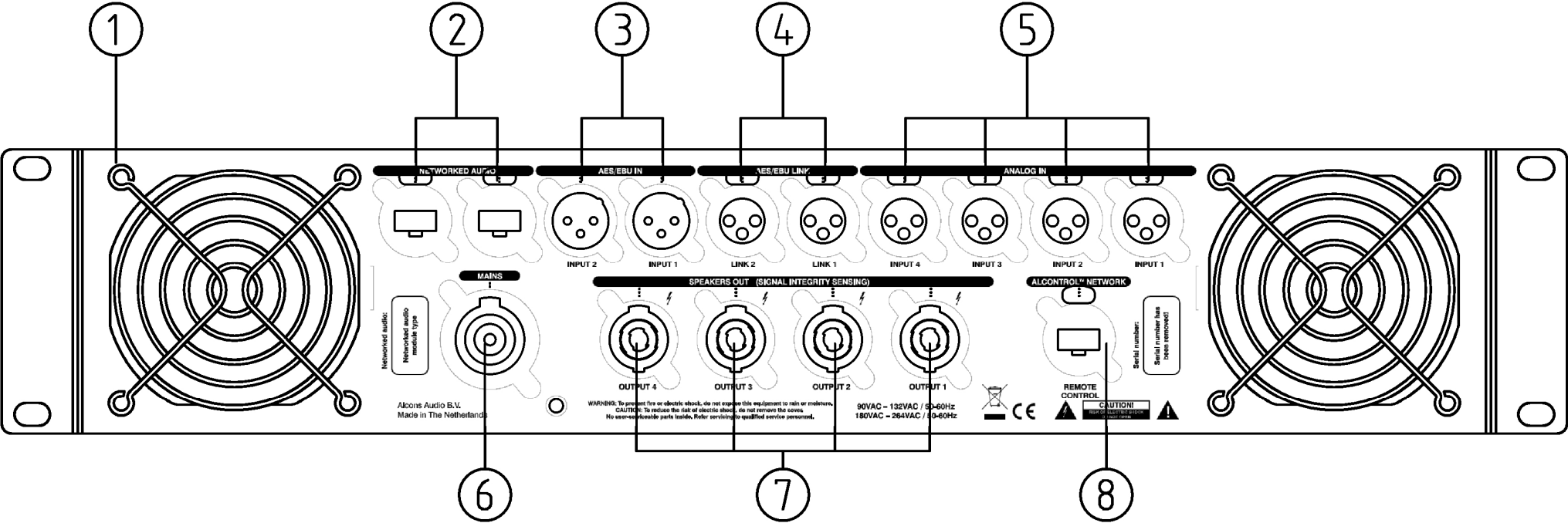

5. Overview

- 1) **Finger guard** The finger guard protects the fan intake. Do not block this area, because this will reduce the airflow.
- 2) **Networked Audio Inputs 2,1** Connect two RJ-45 connectors and leads for the networked audio inputs. One lead is for redundancy.
- 3) **AES/ EBU* inputs 2,1** Connect your AES/ EBU signal source for channel 1 and 2 to the female XLR connector input 1 and connect your AES/ EBU signal source for channel 3 and 4 to the female XLR connector input 2.
- 4) **AES/ EBU** link 2,1** These XLR connectors are internally hardwired to the AES/ EBU input connectors. You can use one of these male connectors to 'daisy chain' channel 1, 2 or 3, 4 input signal to the next amplifier.
- 5) **Analog Input 4,3,2,1** Connect your signal source for channel 1,2,3 or 4 to one of the female XLR connectors.
- 6) **AC power input** Connect the supplied AC mains cable to this connector. Make sure your mains supply matches the specifications stated on the label next to this connector.
- 7) **Outputs 4,3,2,1** Four 4-pole Speakon® connectors are installed to connect your loudspeakers to the amplifier channel 1,2,3 and 4.
- 8) **ALControl™** Connect a RJ-45 connector and lead for the ALControl™ communication. See the ALControl™ manual for further instructions.

*AES/EBU is a standard used for the transport of digital audio signals between professional audio devices, as described in IEC 60958 and AES3. The AES3 and analogue inputs are calibrated according to EBU standard (-18dBFS = 0dBu). The AES3-link connection is actively buffered by the Sample Rate Converter, so no external buffering is required. Thus the AES3-link is active when the unit is switched on.

** AES/EBU can be daisy chained up to 4 amplifiers max.

6. Connections

Inputs

The ALC Sentinel has female XLR connectors for the signal inputs and male XLR connectors for the input links. These connectors are wired with pin 2 'hot'.

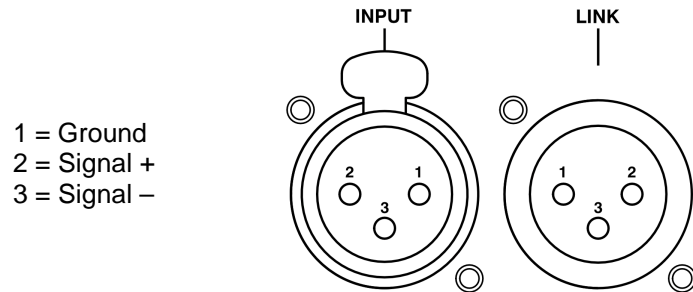

The link connectors can be used to daisy chain the (digital) input signals to another amplifier. If you want to drive the amplifier from an unbalanced source, preferably connect pin 3 to pin 1 in the source connector. If this is not possible, connect pin 3 to pin 1 at the amplifier's connector. Remember, that balanced connections are less susceptible to AC hum, however unbalanced signals can be used for short cable runs.



Always make sure all daisy-chained amplifiers are switched on, both when using analog or digital signal loops.

Outputs

Loudspeakers are connected using Speakon® connectors. For each channel a Speakon® connector is available. Due to the SIS (Signal Integrity Sensing™) feature on the ALC Sentinel, there are four connections per channel instead of two. The two extra wires are used for voltage sensing at the loudspeaker terminals. The output+ and sense+ wires are connected together at the loudspeaker+ terminal, and the output- and sense- wires are connected together at the loudspeaker- terminal. All Alcons loudspeaker cabinets are SIS pre-wired. If your loudspeakers are not prepared for SIS wiring you can connect the sense wires to the output wires at the loudspeaker input. If you do not want to use the SIS feature at all, the sense wires should be connected to the output wires at the amplifier output in the Speakon® connector.

WARNING!

Never connect the sense+ to the output- terminal or vice versa, or short circuit both sense wires! Since you are disabling the amplifier's feedback network, the amplifier can produce a large amount of DC at its output. Through its protection circuitry, the Sentinel will shut-off and will not pass any audio.



6. Connections

The Speakon® connector is wired as follows:

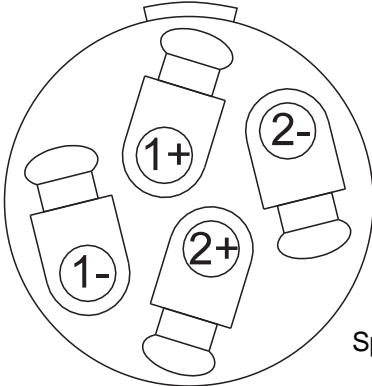

Speakon® male plug viewed from the wiring side

- 1+ Output +
- 1- Output -
- 2+ Sense +
- 2- Sense -

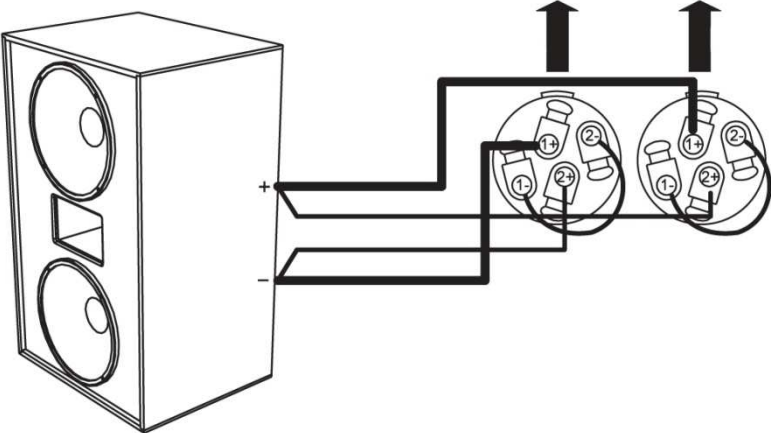

Use bridge mode when you want to combine the power of amplifier channel 1+2 or 3+4 into one loudspeaker load. In bridge mode connect your loudspeaker with or without SIS to the channel 1 and channel 2 outputs (or channel 3 and 4) as shown above. Sentinel 3 only!

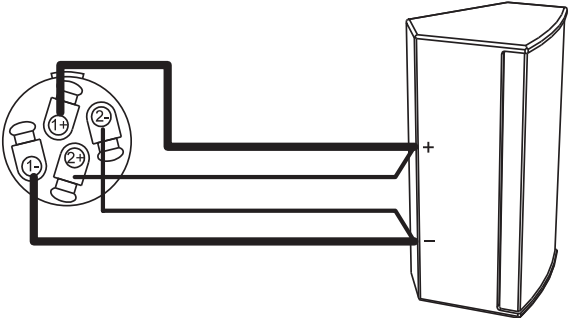

Normal loudspeaker operation

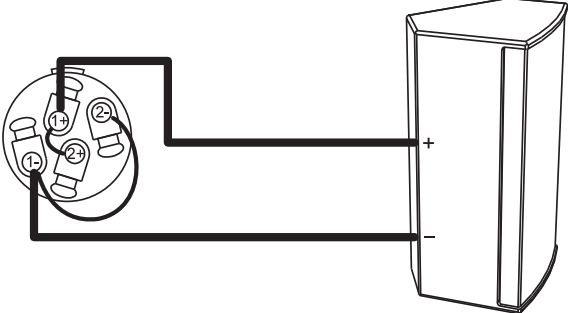

Loudspeaker connection without SIS™



6. Connections

For a given loudspeaker impedance, the proportional power loss as a function of cable length and cable gauge is given in the next table:

	8 Ω				4 Ω			
	1.5 mm ²	2.5 mm ²	4 mm ²	6 mm ²	1.5 mm ²	2.5 mm ²	4 mm ²	6 mm ²
5 meters	1.4 %	0.8 %	0.5 %	0.4 %	2.8 %	1.7 %	1.1 %	0.7 %
10 meters	2.8 %	1.7 %	1.1 %	0.7 %	5.4 %	3.3 %	2.1 %	1.4 %
15 meters	4.1 %	2.5 %	1.6 %	1.1 %	7.8 %	4.9 %	3.1 %	2.1 %
20 meters	5.4 %	3.3 %	2.1 %	1.4 %	10.2 %	6.4 %	4.1 %	2.8 %
25 meters	6.6 %	4.1 %	2.6 %	1.7 %	12.4 %	7.8 %	5.0 %	3.4 %
30 meters	7.8 %	4.9 %	3.1 %	2.1 %	14.5 %	9.3 %	6.0 %	4.1 %
40 meters	10.2 %	6.4 %	4.1 %	2.8 %	18.5 %	12.0 %	7.8 %	5.4 %
50 meters	12.4 %	7.8 %	5.0 %	3.4 %	22.1 %	14.5 %	9.6 %	6.6 %

To calculate the SPL losses from these percentages in dB's, the following equation may be used:

$$\text{dB loss} = 20 * \log(1 - (\% \text{loss}/100))$$

In the next table a few percentages are converted to dBs:

% loss	dB loss
1 %	0.1 dB
2 %	0.2 dB
5 %	0.4 dB
10 %	0.9 dB
15 %	1.4 dB
20 %	1.9 dB
25 %	2.5 dB
30 %	3.1 dB
35 %	3.7 dB



7. Operation

Power On/Off

The mains AC power of the amplifier is switched on when the PowerCon is connected.



Each setting is automatically stored in memory, 30 seconds after the last user change. It is advised, to switch the amplifier off only, 30 seconds after the last instruction / setting change (otherwise the setting change will not be stored); it is also possible to double-click the encoder, with which the settings are manually stored.



Using AES signal in daisy chain - When one of the interlinked amplifiers is switched off, the following amplifier will not receive the AES signal. The reason for this, is that the AES signal is actively buffered.



Panic Mute - By pressing the illuminated rotary encoder for 2 seconds, all channels will be switched into mute. To un-mute, go to the Overview Tab or Gain Tab screen. This feature can be disabled in the Mute preferences menu.



Stand-by mode - By pressing the rotary encoder for 4 seconds, the amplifier can be put in Stand-by mode through the pop-up on/off selection menu: In Stand-by mode the power supplies and amplifier stages are switched on/off, and display is dimmed to 10%. Another way of switching on/off, is through the PowerCON connector on the rear of the amplifier; This way, every function (also the front) is switched off.

7. Operation

Multi-colour LED encoder

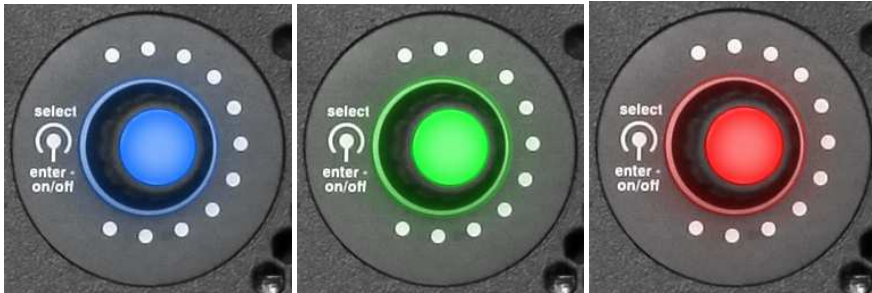

Fig 1.

Fig 2.

Fig 3.

The rotary encoder features a multi-colour LED, which shows the status of the amplifier..

Blue (fig.1)

Normal operation

Blue blinking

EQ or delay settings changed - with changing settings in the equaliser- or delay section, the encoder will blink, indicating that changes have been made to the stored settings.

Green (fig.2)

Initialisation - DSP is being synchronised with the front User Interface (only during amplifier start-up phase).

Saving EQ or delay settings - after pressing the blue-blinking encoder, the new setting is confirmed by a short, green-blinking encoder (in the EQ and delay menu).

Red blinking (fig.3)

Error detected - what causes the error notification, can be checked in the “oplog” (“system” -> “oplog”); After checking the oplog, red blinking stops. Note: the red blinking overrides the blue blinking (changes EQ or delay made) and green blinking (store setting confirmed).

If the encoder/touch screen is not used for 10 seconds, the encoder will dim to extend the life of the LED.



In an error situation (red-blinking encoder), it is not possible to see if changes are made in the EQ-settings (white-blinking encoder) nor if they are being stored (short green-blinking encoder -> white encoder) as the error condition overrules this.



For service purposes, a log file can be downloaded from the controller-amplifier, through the USB port. See procedure in Tab section system/ copy log files.



7. Operation

Touch screen menu

The touch screen function is applied for (de-)activating of a selection on the menu screen. Through the rotary encoder a specific value can be set (turn) and can be confirmed (click).

The menu is divided in different “Tab sections” under which a function-dedicated page is located.

This guide relates to Sentinel amplified loudspeaker controllers with front firmware version from v1.42

7.1 Tab section: Overview

In this section, an overview is given of the most important settings, as they have been selected.

Adjustments of these settings are limited to enable/disable in this section. Value changes of these parameters can be made in each specific function Tab section. Furthermore, the status of signals (green = input signal present, yellow = input signal 0dB, red = output signal clip) and of the amplifier stages temperature (blue = ok, orange blinking = channel close to thermal shut down) is displayed.

Gain - can be activated or de-activated (“gain muted”): Specific values can be entered in the “Gain” section.

Eq - can be activated or de-activated: Specific values can be entered in the “Eq” section.

Delay - can be activated or de-activated: Specific values can be entered in the “Delay” section.

Preset - shows the name of the selected factory system preset: Systems can be selected in the “Presets” section.

Routing – Shows the routing of the audio signal.

System – System parameters can be read or set, that are not required for “daily” operational usage.

Name - shows the customized name that each channel can be given. Pressing this field, activates a qwerty keyboard pop-up, with which the name can be entered (after clicking away the keyboard, one lands in the “Preset” tab section).

Input shows “analog” or “digital”, for the selected input; Also the input channel number is shown (1, 2, 3, 4). Specific values can be entered in the “Routing” section.



7. Operation

7.1 Tab section: Overview

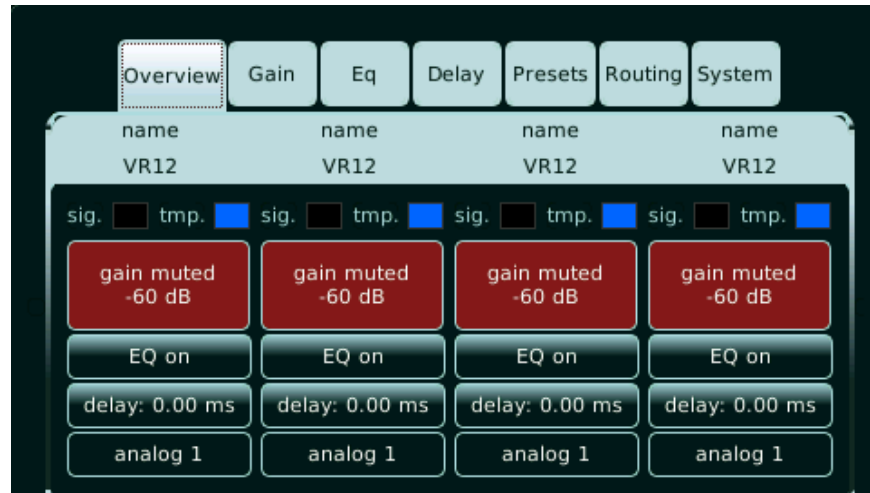

Fig 4. All channels no signal present, gain muted, amplifier temperature normal

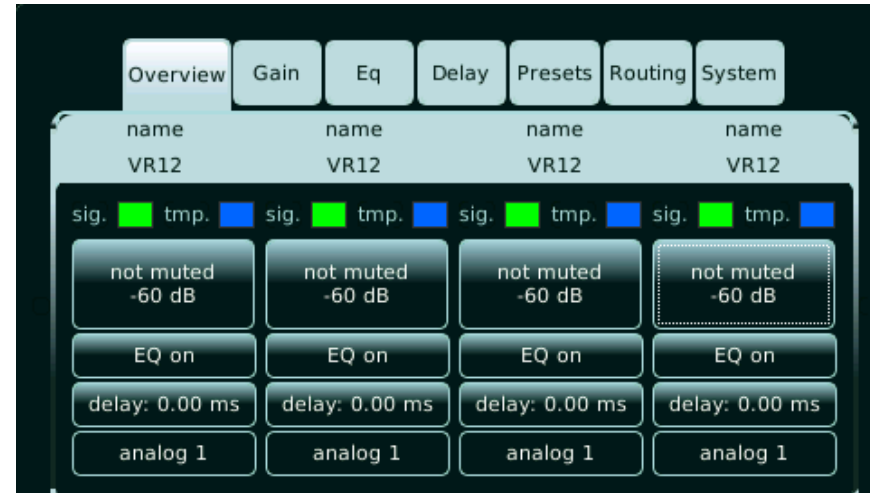

Fig 5. All channels signal present

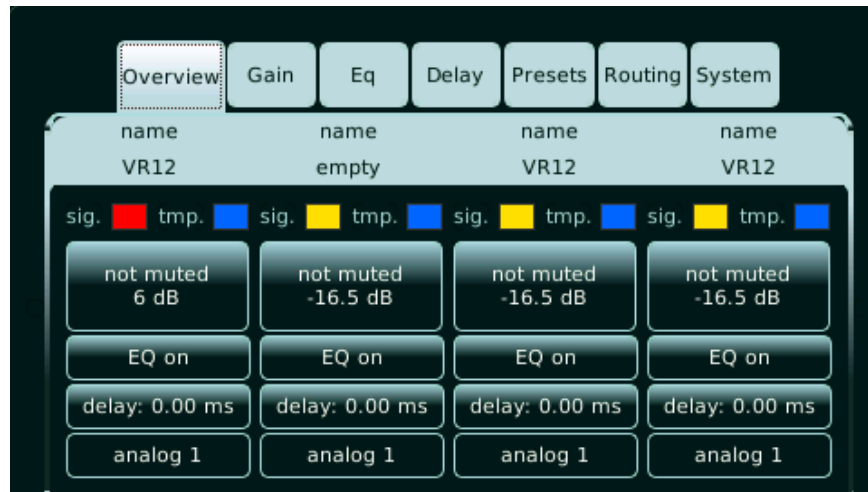

Fig 6. Output signal clip channel 1, signal -16,5dB channel 2-4



7. Operation

7.2 Tab section: Gain

In this section, the gain settings for each of the 4 channels can be entered; Via this Gain Tab section, or the Overview Tab section, this function can be “enabled”/”disabled” (muted) per channel.

Each channel can be muted individually or in cluster; Subsequent channels can be linked, with which these channels follow the same gain setting, as the initial channel has been set (so channel 3 and 4 linked with channel 2, values are set with just channel 2).



The Sentinel features “Panic Mute”: By pressing the illuminated rotary encoder for 2 seconds, all channels are switched into mute. To un-mute the channels, go to the Overview section or Gain section screen. Panic Mute can be switched on/ off in the mute preferences menu through the system tab.

The gain value can be entered between -60dB up to +6dB, in steps of 0,5dB.

The bar-graph indicators located left from the Mute/Gain/Link controls, are the input (left) and output (right) VU-meters. The scales run from bottom to top; The solid bar shows the average signal, the tops show the peak signal; The indicators are green until 0dB, above 0dB they turn from yellow to dark orange. The separate clip indicators blink red and are located above the bar graphs.

The input indicator is located before the gain control, so this functions as “input signal present” indication.

The third bar-graph indicator shows the “Guidance” (gain-reduction): This is the limiting of the amplifier output for the protection of the connected speaker (this can be excursion or RMS limiting); As such, this works different for each speaker/preset. The scale runs from top to bottom, colors yellow to dark orange; When the bar reaches the bottom, maximum compression/limiting is reached. It is not a problem when the gain reduction is activated, but the LF response and overall dynamics will be reduced.

7. Operation

7.2 Tab section: Gain

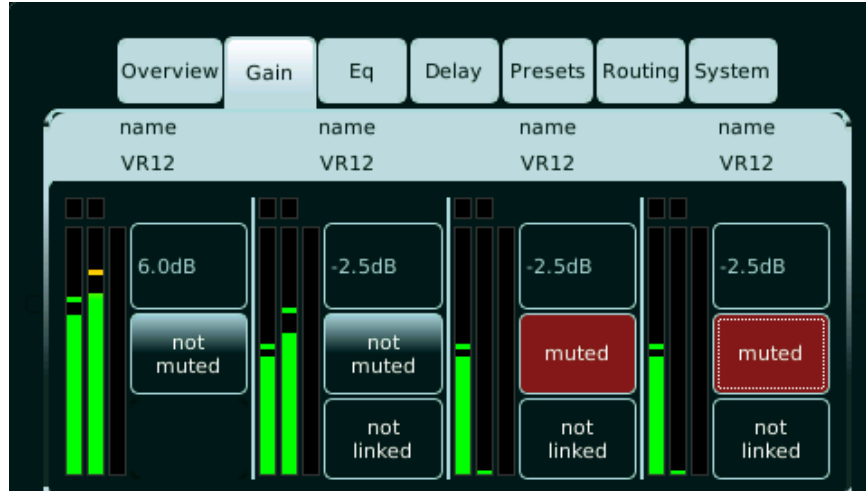

Fig 7. Output channels 3 and 4 muted

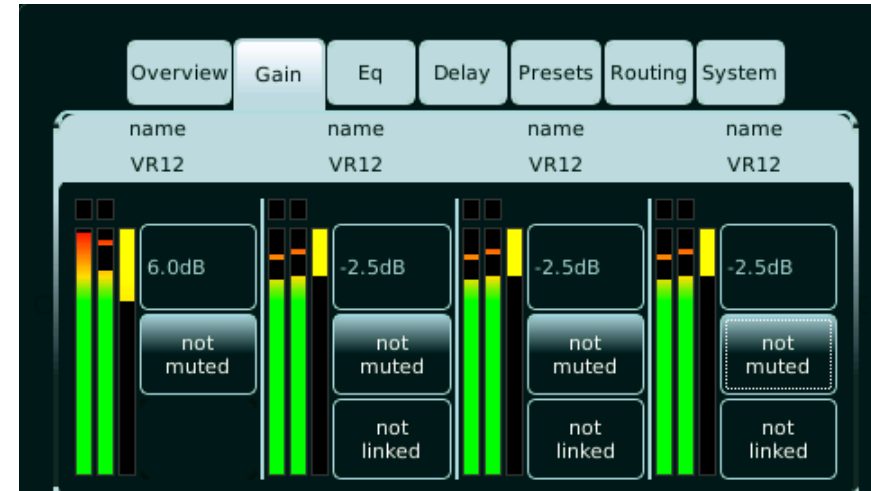

Fig 8. Guidance on all channels

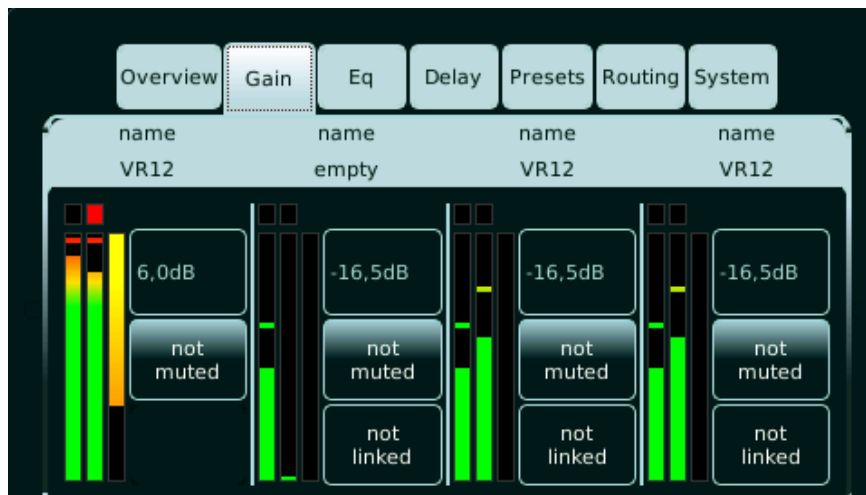

Fig 9. Output gain clip on channel 1



7. Operation

7.3 Tab section: EQ

In this section, the equalizing settings for each of the 4 channels can be entered; Via this EQ Tab section, or the Overview Tab section this function can be “enabled”/ ”disabled” (bypass) per channel.

Per channel there are 6 free-configurable equalizing bands available: Controllable parameters are frequency (f), q-factor (Q) and gain (g). Every band can be functionally changed from parametric equalizing to low-pass, high-pass, low-shelf or high-shelf filtering. In addition, each band can be by-passed or switched-off individually. Each parameter can be set to fine or coarse. (“fine” shown on picture). With the “rst.” button, all EQ parameters can be reset on the current channel.

Use the “polarity reverse” button (red is activated) to reverse the polarity. Please be aware that this stays activated when the EQ is disabled.

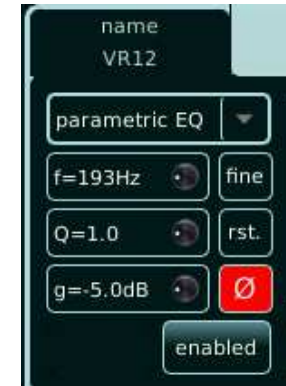

When switching-off the band, the values are re-set to factory default!

Each band can also be by-passed, while keeping the settings, by touching the band button. To re-activate the band again, the band button needs to be touched another time.

Each band has its own color in the display graph; The color of the active band that's being set lights up. The total summed equalizing of that channel (up to 6 bands) is being indicated by a white line.

Subsequent channels can also be linked, with which these channels follow the same EQ settings, as the initial channel has been set. For example channel 3 and 4 linked with channel 2, values are set with just channel 2.



Changed settings in the EQ section need to be confirmed/saved by pressing the rotary encoder.

7. Operation

7.3 Tab section: EQ



Fig 10. Equalizer section channel 1, band 1 parametric EQ enabled and active

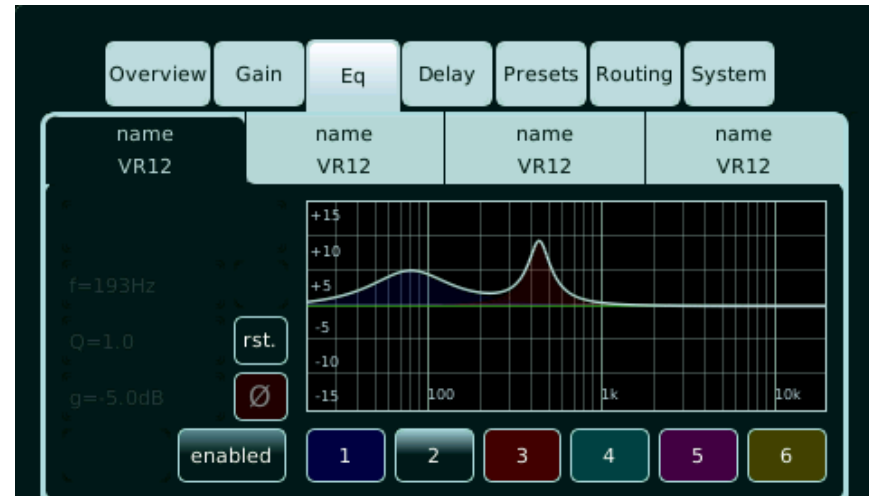

Fig 11. Equalizer section channel 1, band 2 enabled and bypassed

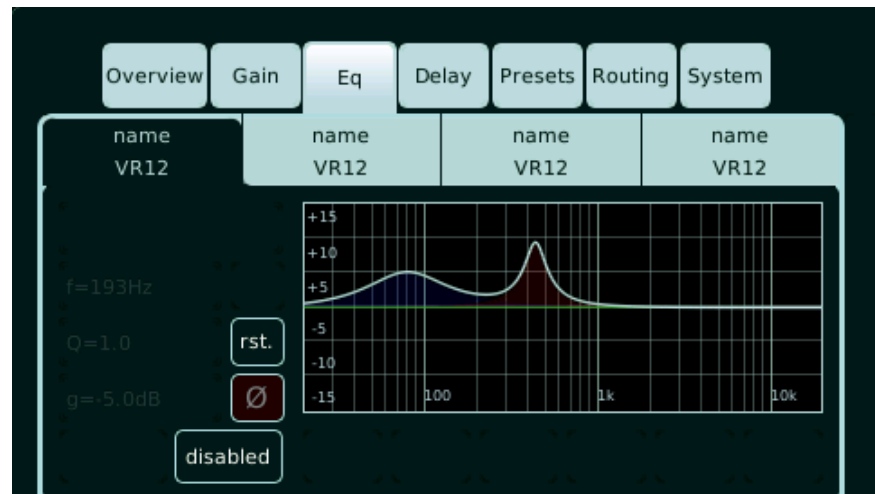

Fig 12. Equalizer section channel 1, disabled



Fig 13. Equalizer type selection .

7. Operation

7.4 Tab section: Delay

In this section, the delay settings for each of the 4 channels can be entered; Via this Delay Tab section, or the Overview Tab section this function can be “enabled”/”disabled” per channel.

The delay function can be set to “absolute”, with which delay values are set as actual absolute values, including the latency of the Sentinel (used when Sentinels are mixed with other amplifiers/delay devices). Delay set to “relative” sets the delay values, excluding the latency of the Sentinel (used when solely Sentinels are deployed).



From firmware v1.36 or higher, a DDP-equipped ALC needs 1,875 ms latency, to match a Sentinel amplifier.

Per channel, the delay values can be entered in meters (mtr), feet (ft) and milli-seconds (ms) to a maximum of 99,9meters, 327.67ft and 341,42ms. The step size can also be adjusted: per encoder click 0,15meters, 0.5ft, or 0,52ms (“coarse”) and 0,01meters, 0.01ft or 0,01ms (“fine”). Subsequent channels can also be linked, with which these channels follow the same EQ settings, as the initial channel has been set. For example channel 3 and 4 linked with channel 2, values are set with just channel 2.



Fig 14. Delay tab, all channels enabled, delay “relative”

7. Operation

7.5 Tab section: Presets

In this section, the system presets for each of the 4 channels can be selected; All available system presets are organized per series and can be called and selected through the rotary encoder.

Each channel can be assigned a different system preset; This can be an Alcons system, but it is also possible to use the amplified loudspeaker controller as a “non-Alcons-specific” linear amplifier, through the “LINEAR” preset. Herewith, no system processing is activated, but all other processing functions (equalizer, delay, routing, gain) remain active.

When a system features a bi-amp or multi-amp configuration (requiring 2 or more amplifier channels, i.e. LR28, LR24, BC543), then at selecting the preset, automatically the consecutive channel/s is/are reserved for the 2nd (3rd + 4th) channel of the selected system. These additional channels (“Slave”) are not individually controllable, but follow the settings of the 1st set channel (“Master”).

For example when preset “LR24” is being selected (4 channels required) on channel 2, a message pops-up “not enough channels free for this preset” and the selection is refused. The preset key will show “empty”; No preset is set and the amplifier will not pass any audio. (see fig. 16)

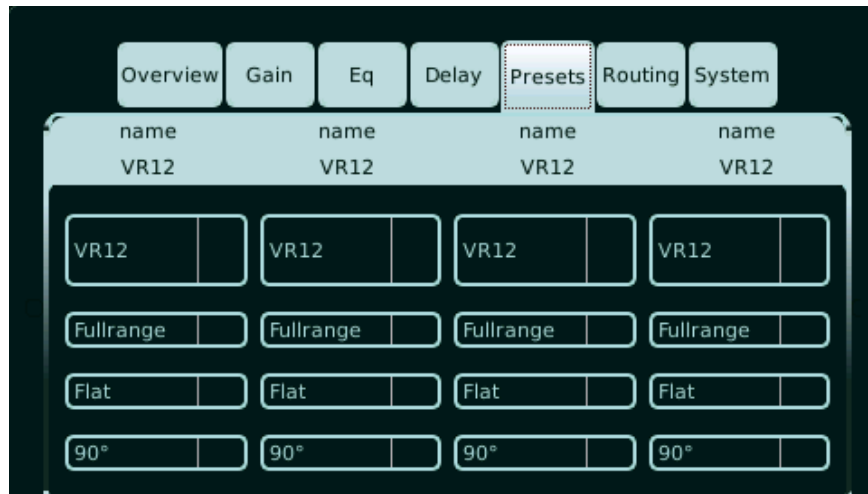

Fig 15. Preset tab, channel 1 to 4 factory preset selected



Fig 16. Bi-amp preset channel 1 disabling active control channel 2

7. Operation

7.5 Tab section: Presets



Fig 17. Scroll bar for selecting the different system series



Fig 18. Scroll bar for selecting the different system presets



HF protect deleted!
(use correct preset)

When driving speaker systems with the red decal “HF protect deleted!” on the rear connector panel, make sure the ALC preset library is v2.0 or higher. Ignoring this can result in serious component damage and will void warranty!

7. Operation

7.6 Tab section: Routing

In this section, the routing for each of the 4 channels can be selected; Through the 4x4 matrix, per channel (4) a choice is available of available inputs (4). Up to 4 inputs can be selected per channel (i.e. mixed-mono signal for subwoofers).

In addition, analogue or digital (AES3) input signal can be selected; With digital inputs, the sample rate is automatically up/down sampled to 96kHz internal frequency. The input sampling rate is also shown: Channel 1 and 2 show the AES3 sampling rate of input AES1 and channel 3 and 4 show the AES3 sampling rate of input AES2.

The Sentinel3 also offers the choice of operating the amplifier channels in bridge-mode (1+2, 3+4). (see fig.19)

The bridge-mode option is not available on the Sentinel10 (and as such not visible on the menu/display). (see fig.20)

When the digital input is selected, the sample rate of the source is displayed as long as there is a valid AES/EBU connection.

If the digital connection is lost, this is indicated as "no signal".



For using the amplifier stages in bridge-mode, a special loudspeaker cable adapter is required! Sentinel 3 only.



Fig 19. Routing screen of Sentinel3 (with bridge-mode option)

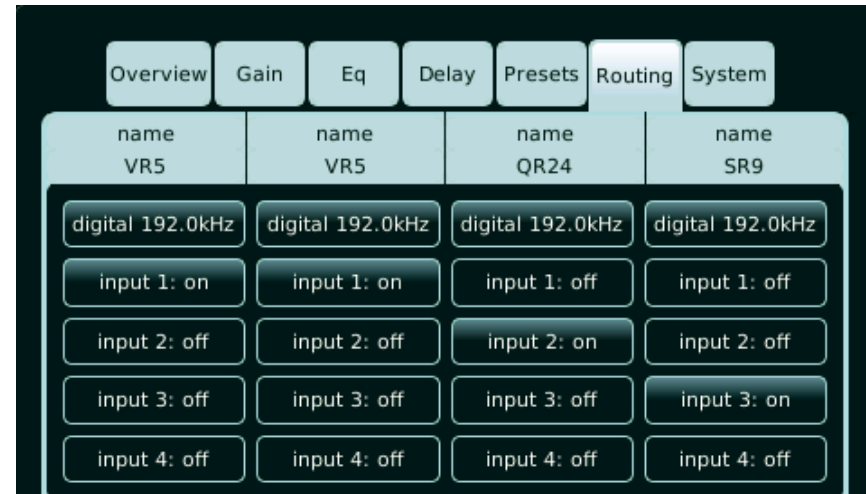

Fig 20. Routing screen of Sentinel10

7. Operation

7.7 Tab section: System

In this section, there are the system parameters that can be read or set, that are not required for “daily” operational usage. Through separate sub-tabs, operational data read-outs can be displayed and changed.

7.7.1 Speaker - this section shows the measured speaker (system) impedance, per channel; This read-out offers real-time load-verification, with which state of speaker function can be determined. Note: for an accurate reading, ample signal needs to be available (“the higher the signal, the higher the accuracy”). The measurement range is between 1,5 Ohms and 20 Ohms, above/below - - is indicated. (see fig.21)

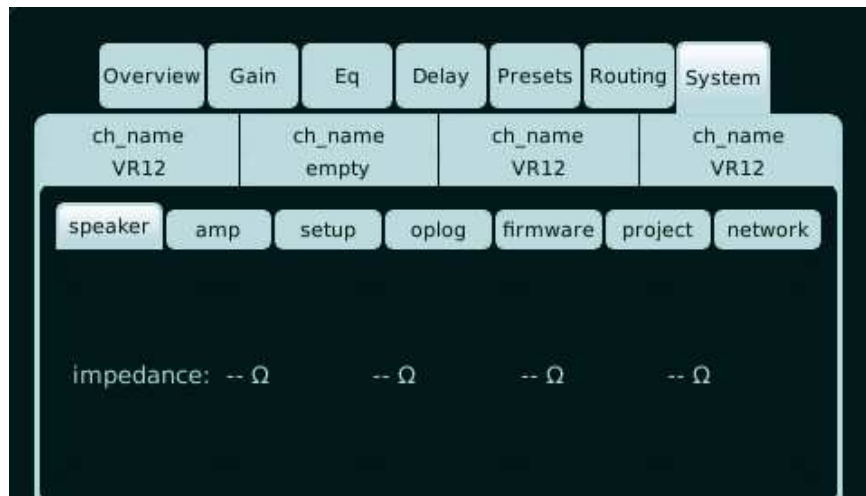

Fig 21. Speaker impedance read-out

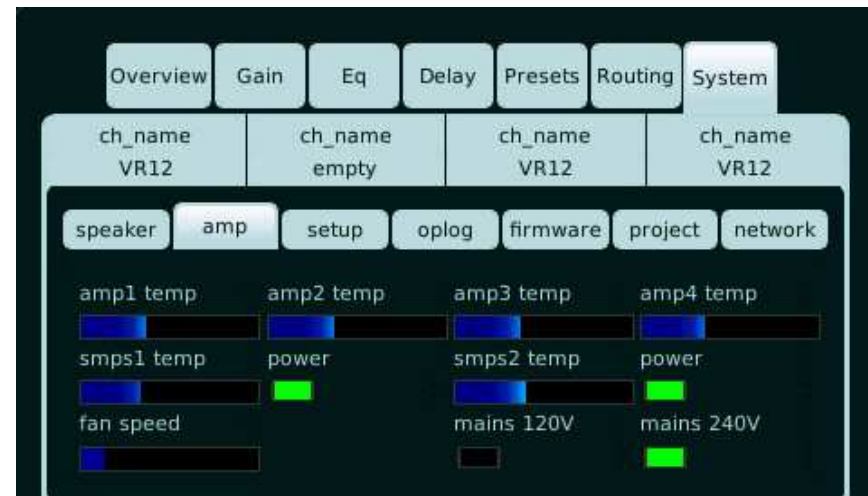

Fig 22. Amplifier status, temperature scales, fan speed level 1, AC mains 240V indication

7.7.2 Amp - this sections indicates the temperature of the power supplies (“SMPS” 2x) and amplifier stages (“amp” 4x) through a color scale from blue to red. (see fig.22)

The automatically selected AC power band is shown as “AC 120V” or “AC 240V”. The “power” indication shows the status of the smps1 and smps2 power supplies; If green, the smps is working properly; If the indication illuminates red, the smps is out of order. Then, the redundancy switching will maintain amp operation from only one smps, albeit at lower output levels.

7. Operation

7.7 Tab section: System

7.7.3 Setup - In this section, different system functionalities can be set, like system lock, screensaver function (the “eye”), date/time and mute-setting options. (see fig.23)

lock system

With pressing this button, the QWERTY keyboard pops-up, to enter a password code; Confirm code and the active tab switches to Overview tab, with which all tabs are locked and only the Mute buttons can be operated. (see fig.23)

lock preset

With pressing this button, the QWERTY keyboard pops-up, to enter a password code; Confirm code and the active tab switches to Overview tab, with which System tab and the Preset tab are locked. (see fig.23) To unlock, touch any locked tab and the QWERTY keyboard will pop-up, asking for password.

backlight brightness

This can be adjusted, in “manual” (with slider bar) or “automatic” (through light sensor behind the front panel); Both the brightness of the display and the Alcons logo are adjusted. (see fig.24)

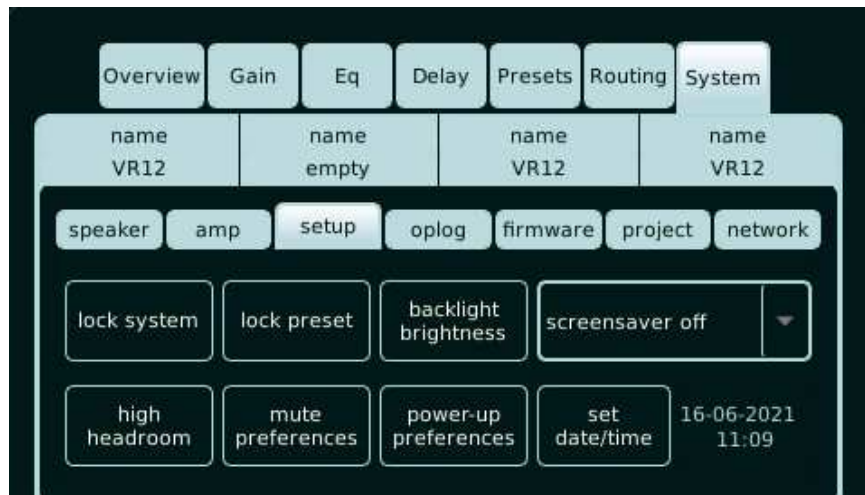

Fig 23. Set-up menu with setting options

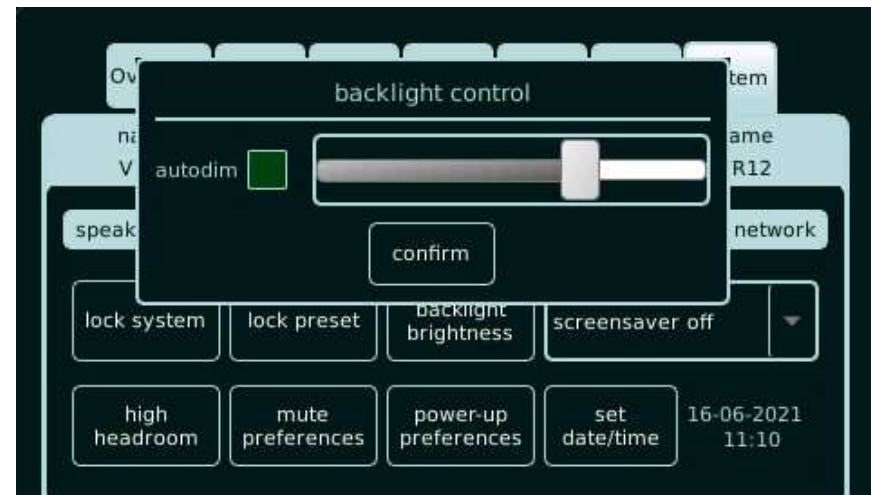

Fig 24 Backlight control set-up menu

7. Operation

7.7 Tab section: System

screensaver

this function enables time-out setting for the screen saver (the “Eye”). Selectable settings are: Activation after 30 seconds, 2 minutes, 10 minutes or off. (see fig.25)

high headroom/low noise

the analogue input sensitivity can be adjusted; “High headroom”, allows driving the amp with an analog input signal +21dBV (+23dBu). Use this setting when the signal source can exceed +6dBV (+8dBu), usually higher-SPL applications. (see fig.25)

In the “Low noise” setting the input stage is fully driven with a +6dBV (+8dBu) signal. The signal is internally boosted to fully utilize the ADC's quantization space, resulting in a better signal-to-noise ratio. Use this setting when working with signals not exceeding +6dBV (+8dBu), usually low-SPL applications. This applies to the analogue inputs only. In both settings the overall gain remains the same. (see fig.26)

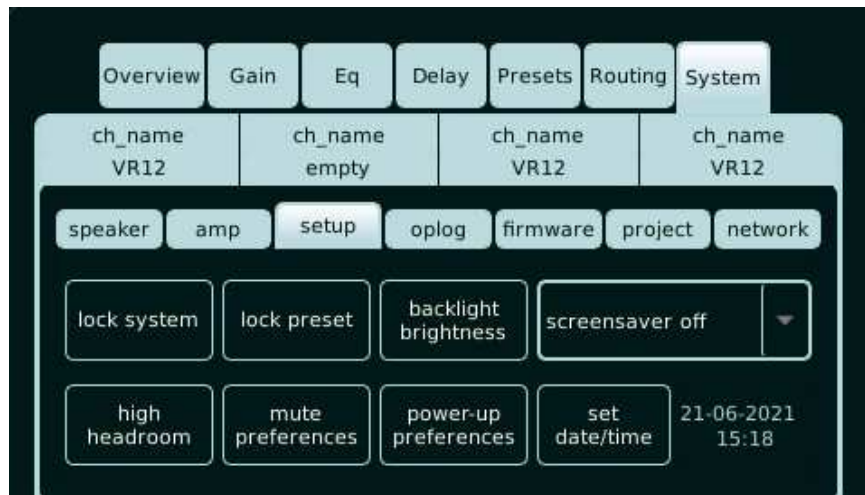

Fig 25. High headroom setting

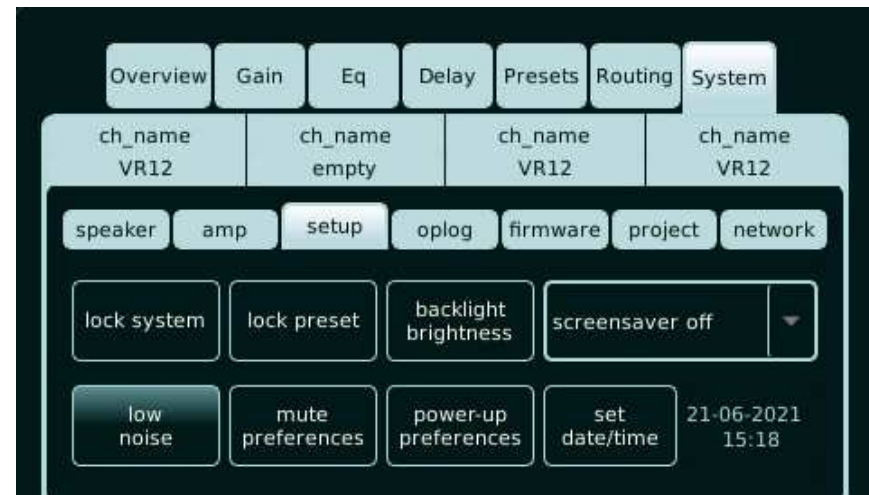

Fig 26. Low noise setting

7. Operation

7.7 Tab section: System

mute preferences

different muting options prevent unwanted passing of audio, while being active in the Preset tab, or with startup. (see fig.27)

power-up preferences

this allows the start-up behavior of the amplifier upon connecting to the Mains.

Default is "on"; this is the normal behavior where the amplifier starts up completely, when the amplifier is connected with Mains power.

If "standby" is selected, the amplifier will start up the front controller but the power supplies and the amplifier stages will remain off.

With this setting, it is less likely to trip a mains circuit breaker in an application with many amplifiers, by bringing the amplifiers out of standby in a controlled manner (in combination with the power sequencer in the ALControl™ program).

The "previous" mode allows the amplifier to return to the situation it was in before the Mains power went out. So if the amplifier was switched on, the amplifier will restart fully on and if the amplifier was in standby, it will start up again in standby when the Mains voltage returns. (see fig.28)

set date/time

date and time can be adjusted, with which both the visible date/time dialog as well as the internal "date/time stamp" in the log files is changed.



Fig 27. Mute preferences menu

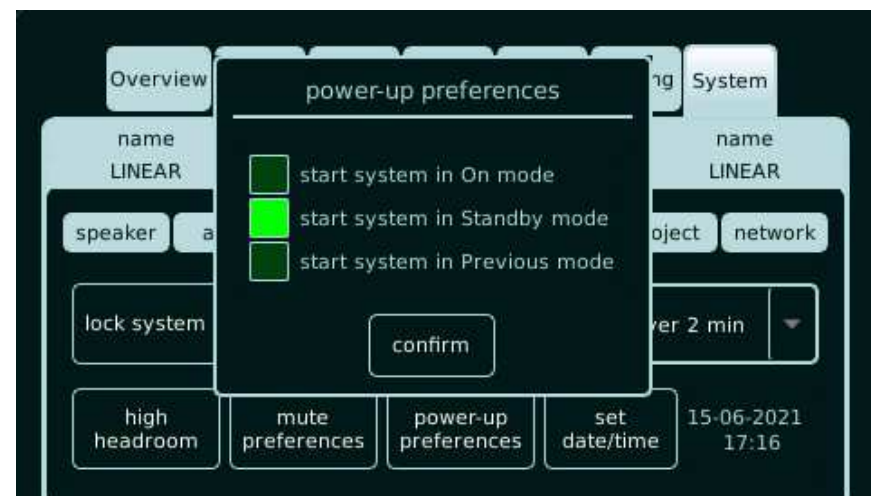

Fig 28. Power-up preferences menu

7. Operation

7.7 Tab section: System

7.7.4 Olog

This “operation log” section shows the status of the different sections inside ALC. When the illuminated encoder indicates a certain color/status, the olog shows the actual report on the system status. When selecting “oplog” the function status of the encoder is reset (red blinking to white).

Clear oplog - touching this button cleans the log files/messages on the display: It does NOT clean the internal logging of the Sentinel, as that (more extensive) data cannot be erased by the user. (see fig.29)

E-mail settings

To receive notifications by email, the amplifier must be connected to a network with Internet access. In the System>network tab an IP address must be set or obtained via DHCP.

In the System-oplog tab, the preferences for e-mail can be entered via the button "e-mail settings". These include e-mail address for the recipient of the e-mails and the mail priority eg only "major errors" or "all errors". The major errors are the ones where the amplifier may have gone into protect and action is required. (see fig.30)

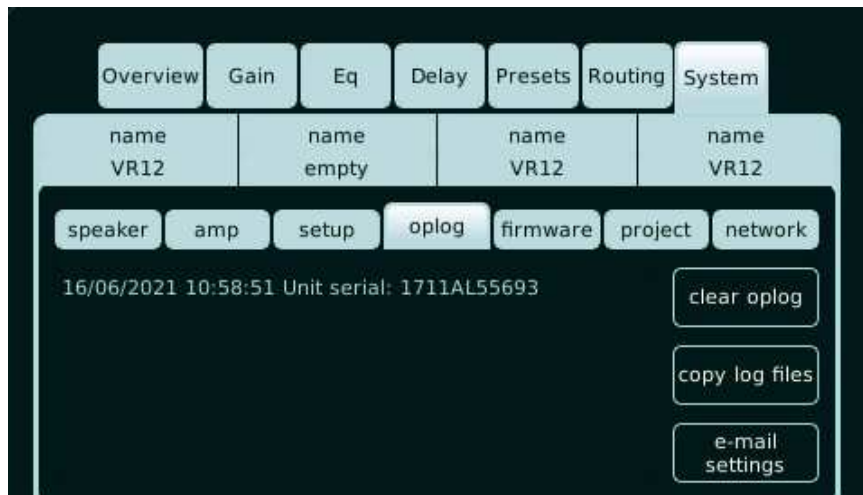

Fig. 29. Amplifier operation log report



Fig 30 Amplifier e-mail notification setting



The internal logging reports any setting and operating status of power supplies, amplifier stages, main controller, DSP and front control. It stores these data for a maximum of 1025 hours, which equals a period of around 42 days of non-stop operation logging.



7. Operation

7.7 Tab section: System

7.7.5 Firmware

The different firmware/ library versions are shown here. Through the “update” keys (+ USB connector on the front) firmware updates can be loaded. (see fig.31)
The procedures for updating are described in separate instruction/ release notes, which come with the distributed software.

Read these instructions carefully before updating an ALC Sentinel amplifier. Ensure that the amplifier is never switched off during updating and that the mains power supply is stable. (see fig.31)

It is highly recommended that a firmware update is done at an appropriate moment. i.e. not “minutes” before a show.



Fig 31. Amplifier firmware information and update



Fig 32. Project storage or recall

7.7.6 Project

With “store project” and “recall project” the settings of all sections of the amplifier can be stored in a Project file / User preset. Up to 100 user presets can be stored internally; Each project can also be stored externally; For this, a USB stick needs to be plugged into the front-located USB connector. Through the QWERTY keyboard each project file can be renamed. A full 100-project user file takes up around 2MB. Recalling or loading a project can be done from internal or external (USB) storage. With “remove project”, when recalling a project, you can also choose from the pop-up menu to permanently remove the project from the list. This applies to both internal and USB storage. (see fig.32)

7. Operation

7.7 Tab section: System

7.7.7 Network – The shown MAC (media access control) address is a unique identifier on the ALC Sentinel network interface, used for communications on a physical network segment. Before the unit is accessible via the network it first needs an IP address. There are two ways of getting an IP address: automatically (via DHCP) or manual. If the DHCP is enabled the unit will get an IP address from the DHCP server in the network, if one is available.

The other way is by manually entering the IP address via the "edit IP address" button. The "edit IP address" button will be activated when the DHCP is disabled. When an ALC Sentinel is connected to a network, the assigned IP address will be shown if DHCP is enabled, otherwise the previous assigned or manual entered IP is displayed.

The "maintenance" tab is intended for service purposes only. A "blink logo" tab is added for easy identifying the amplifier in a multiple rack assembly.



Fig 33. Network information



Project files are transferable between ALC Sentinel amplifiers. For installed situations it is advised to save individual amplifier project files for backup purposes.

7. Operation

7.8 Remote Control through a VNC client

The ALC Sentinel is equipped with a VNC server to access the display screen remotely. This can be useful to operate a number of ALC Sentinel amplifiers connected to a wired LAN. To access the VNC server, a VNC client must be installed on the remote device, this can be a laptop, desktop PC, smartphone or tablet which can run VNC client software.

An example of a (free) Windows VNC client is TightVNC, the only thing it needs is the IP address of the ALC Sentinel before connecting. Apple devices and Linux distributions come standard with VNC client software. For android phone's and tablets, different client app software is available. Make sure it supports VNC as that is different from the "remote desktop" protocol. A nice simple and fast version is Remote VNC from Yongtao Wang. Most VNC clients allow you to optimize for speed. When response is slow, check if the bpp (color quality) can be set to a lower mode, i.e. 8bpp setting and that the screen resolution is set to auto or 480x272 pixels (ALC Sentinel standard display resolution).

With most VNC clients it is only necessary to set the IP address of the ALC Sentinel and press connect. The ALC Sentinel operates with a DHCP server to acquire an IP address from the router in the LAN. Beware, this can take up to 5 minutes. In the system->network tab, the IP address is displayed. This tab also features a "blink logo" button which can be used to identify units later on.

Port 5900 is used by VNC and the ALC Sentinel. Most client software set this port as default, otherwise you can change this in the client software.

Devices with a keyboard and mouse can select all selection-boxes/buttons with the mouse and turn up/down parameters with the up/down key and page-up/page-down key for fast changes. The EQ/Delay boxes need to be confirmed to have effect to do this press the enter button to confirm. The advantage of a desktop/laptop is that multiple units can be connected to at the same time.



7. Operation

7.8.1 Remote Control with the Virtual Encoder™



Fig 34. Virtual encoder

For touch screen devices, the ALC Sentinel display features a transparent button to activate a Virtual Encoder™. This allows you to change certain parameters that need the encoder motion. To activate this Virtual Encoder™, press the area next to the System tab(see arrow), this will then pop up the Virtual Encoder™.

To change for example the Q in the “EQ” tab section:

Press the Q selection box (the box outline turns green when selected)

Press the area next to the system button to let the Virtual Encoder™ pop up. turn the dial to get the desired Q, the dial starts blinking to indicate a parameter change.

Press the enter on/off button to confirm. The Virtual Encoder™ has the color schemes of the actual encoder. (see fig.34)

This Virtual Encoder™ can also be used to get the ALC Sentinel in or out of standby mode and panic mute.

8. Safety

Protection circuits

Guidance

This is the limiting of the amplifier output for the protection of the speaker (this can be excursion or RMS limiting); Thus works different for each speaker/preset. The scale runs from top to bottom; When yellow bar reaches the bottom, maximum compression/limiting is reached. It is not a problem when the gain reduction is activated, but the LF response and overall dynamics will be limited.

Speaker cable short circuit detection

If there is a short circuit/very low impedance in the speaker cable/speaker, the channel on which the short circuit was detected will be muted by the DSP. An error message "short detected on ch x" will appear in the log.

Once the short circuit is cleared, the channel can be unmuted and resume normal operation, to do this, first press the mute button of the affected channel to show "muted", then unmute the channel to resume operation. This protection comes on top of the hardware short-circuit detection of the amplifier modules.

Temperature protection

The ALC Sentinel is cooled by two 80mm variable speed fans located behind at the back of the amplifier. Fan speed increases only as required by measured temperatures, keeping fan noise to a minimum. Under extreme thermal load the fans will force a very large volume of air through the heat sinks. If one of the SMPS power supplies or Amp stages surpasses the maximum allowed temperature, the ALC Sentinel temperature protection circuits become active and will shut down particular components.

To indicate this, the rotary encoder is flashing and a message will appear on the oplog screen.

SMPS power supply protections

The power supplies will check the overvoltage/ under voltage during start up.

Also a current limiter will be become active during operation. The amplifier will shut down during a possible Mains dip.

Amp module protections

There are several error protection circuits on each module.

The speaker outputs have short circuit protection. Also the SIS circuit are protected on faulty +/- wiring and short circuit.



9. Service and support

Warranty

Summary

Alcons Audio BV warrants the original purchaser and any subsequent owner of each new Alcons product, for a period of three years from the date of the original purchase by the original purchaser that the new Alcons product is free of defects in materials and workmanship. Alcons Audio BV warrants the new Alcons product regardless of the reason for failure, except as excluded in this warranty. In order to obtain warranty, you must keep the original sales receipt to establish the exact date of purchase.

Items excluded from warranty

Warranty does not cover any product which has been damaged because of any misuse, accident, or negligence. Warranty also does not extend to a new Alcons product if the serial number has been defaced, altered or removed.

What we will do

Alcons Audio BV will replace defective parts and repair malfunctioning products, regardless of the reason for failure (except as excluded). Warranty work can only be performed at our authorized service centres, or at our factory.

Disclaimer

Alcons Audio BV is not liable for any damage to loudspeakers, amplifiers, or any other equipment that is caused by negligence, misuse or improper installation of the ALC Sentinel amplifiers. Alcons Audio BV is not liable for any incidental damages resulting from any defect in the new Alcons product. This includes any damage to another product or products resulting from such a defect.

Alcons Audio BV reserves the right to change specifications without notice.



9. Service and support

Error log list

When the illuminated encoder indicates a certain color/status, the olog shows the actual report on the system status.

Component	Error type (oplog)	Result	Action by user	
Amp module	Over voltage on V+	Amp module off, 1 second cycle	None, unless it starts preventing normal operation then repair is required	
	Over voltage on V-	Amp module off, 1 second cycle	None, unless it starts preventing normal operation then repair is required	
	Under voltage on V+	Amp module off, 1 second cycle	None, unless it starts preventing normal operation then repair is required	
	Under voltage on V-	Amp module off, 1 second cycle	None, unless it starts preventing normal operation then repair is required	
	Overload Error	Amp module off, 1 second cycle	Amp output shorted? check cables	
	Switching frequency	Amp module off, 1 second cycle	None, unless it starts preventing normal operation then repair is required	
	Amplifier Fail	Emergency stand-by mode	Repair is required.(remove Amp power cable)	
	DC error	Amp module off, 1 second Cycle	Check inputs, otherwise repair is required	
	Over voltage on VDR	Amp module off, 1 second cycle	None, unless it starts preventing normal operation then repair is required	
	Under voltage on VDR	Amp module off, 1 second cycle	None, unless it starts preventing normal operation then repair is required	
Power supply	AmplifierReady	N/A		
	Over temperature	Amp module off	Should be prevented by limiter	
	Signal Integrity Sense (SIS) error	Amp module off	Cable error (wire short, crossed sense wires) or amp hardware failure	
	Short circuit	DSP mutes the channel (no output)	check speaker+cable, a mute cycle resets the channel (mute>unmute)	
	SMPS has been disabled but no fault detected	None, purely status readout		
	SMPS Fail pin was set but the SMPS hasn't been enabled	None, purely status readout		
	SMPS is disabled and the fault was detected	None, purely status readout	SMPS hw defect or mains power dip, in this case amp will recover	
	Fans	Fan error 1; fan error 2	A fan stopped, amplifier in safe mode, with both belonging amp modules switched off. The remaining fan (I.e fan 1) increases speed for proper cooling of amp ch 1+2 or amp ch. 3+4 (fan 2). When both fans fail,the amp goes into emergency standby mode	clear the fan obstruction or return to service centre if fan won't start anymore
	Mains Voltage	Mains voltage out of window	System off	Check mains voltage, this amp needs at least a 16A outlet
	I2C bus	No mains voltage or voltage below minimum	System off	Make sure the mains Voltage is stable, especially on generators
Mains voltage above absolute maximum		System off	Make sure the mains Voltage is stable, especially on generators	
Temperature	Start-up fault	System does not start	This can happen when main Voltage is too low	
	Communication error	No readout on the amplifier module, could mean no functional protections	Try restart. Return unit if problem keeps existing	
AC	Bus locked up	No communication between front and peripherals	Needs PowerCon switch on/ off	
	Temperature error	Emergency stand-by	Improve system air flow	
AC	Front_AC_Reset	DSP reset	None, Amp restarts automatically after mains dip	
	Front_Err_ACFail	100ms no sound	None, Amp restarts automatically after mains dip	



9. Service and support

Contact information

Mailing address:

Alcons Audio BV
De Corantijn 69
1689 AN ZWAAG
The Netherlands

Tel.: +31 (0)229 283090
Fax.: +31 (0)229 283099

World Wide Web:

<https://www.alconsaudio.com>

E-mail:

info@alconsaudio.com



10. Specifications

ALC Sentinel 3

Input sensitivity for max RMS power	@ 4 Ω	1.22 Vrms / +3.9 dBu
Maximum input level		+24 dBu
Input impedance		44 kOhm balanced
Input CMRR	@ 1 kHz	67 dB
Frequency response	all loads	0 Hz – 50 kHz +0 /-3 dB
Gain		32 dB / 40x
Channel separation		100 dB
THD+N, IMD	@ 20 Hz – 20 kHz, 350W, 4 Ω	<0.004 %
S/N ratio	analog input	>112 dB A-wght
S/N ratio	digital input	>118 dB A-wght
Noise floor		typical 7uV, max 8uV (unweighted)
Damping factor	@ 1 kHz, 8 Ω	>10.000:1
Stereo power	@ 8 Ω RMS 1% THD	380 W
	@ 4 Ω RMS 1% THD	750 W
	@ 2 Ω RMS 1% THD	980 W
Bridged mono power	@ 8 Ω RMS 1% THD	1400 W
	@ 4 Ω RMS 1% THD	1820 W
Mains supply voltage		90 - 132 VAC; 180 – 264 VAC @ 50-60 Hz automatically selected
	idle	70 VA
	@ 1/8 of full power into 4 Ω	790 VA
	@ full power into 4 Ω	2300 VA
Latency		2.9 ms
Operating condition		-10°C ...+40°C / +14°F...+104°F
Weight		8,8 kg/ 19,4 lb
Housing		19 inch rack mount, 2 HE, 408 mm / 16 inch deep behind the mounting surface
Dimensions (h x w x d)		88x484x440mm/3.5"x19"x17¼"



10. Specifications

ALC Sentinel 10

Input sensitivity for max RMS power	@ 4 Ω	2.12 Vrms / +8.7 dBu
Maximum input level		+24 dBu
Input impedance		44 kOhm balanced
Input CMRR	@ 1 kHz	67 dB
Frequency response	all loads	10 Hz – 60 kHz +0dB, -3dB
Gain		32 dB / 40x
Channel separation		100 dB
THD+N, IMD	@ 20 Hz -20 kHz, 1000 W, 4 Ω	<0.005 %
S/N ratio	analog input	>112 dB A-wght
S/N ratio	digital input	>118 dB A-wght
Noise floor		typical 18uV, max 20uV (unweighted)
Damping factor	@ 1 kHz, 8 Ω	>10.000:1
Stereo power	@ 8 Ω RMS 1% THD	1450 W
	@ 4 Ω RMS 1% THD	2500 W
	@ 2 Ω RMS 1% THD	2450 W
Mains supply voltage		90 - 132 VAC; 180 – 264 VAC @ 50-60 Hz automatically selected
	idle	240 VA
	@ 1/8 of full power into 4 Ω	2060 VA
	@ full power into 4 Ω	3450 VA (active limited)
Latency		2.9 ms
Operating condition		-10°C ...+40°C / +14°F...+104°F
Weight		11.6 kg / 25.5 lb
Housing		19 inch rack mount, 2 HE, 448 mm / 17.6 inch deep behind the mounting surface
Dimensions (h x w x d)		88x484x480mm/3.5"x19"x18.9"



11. Block diagram

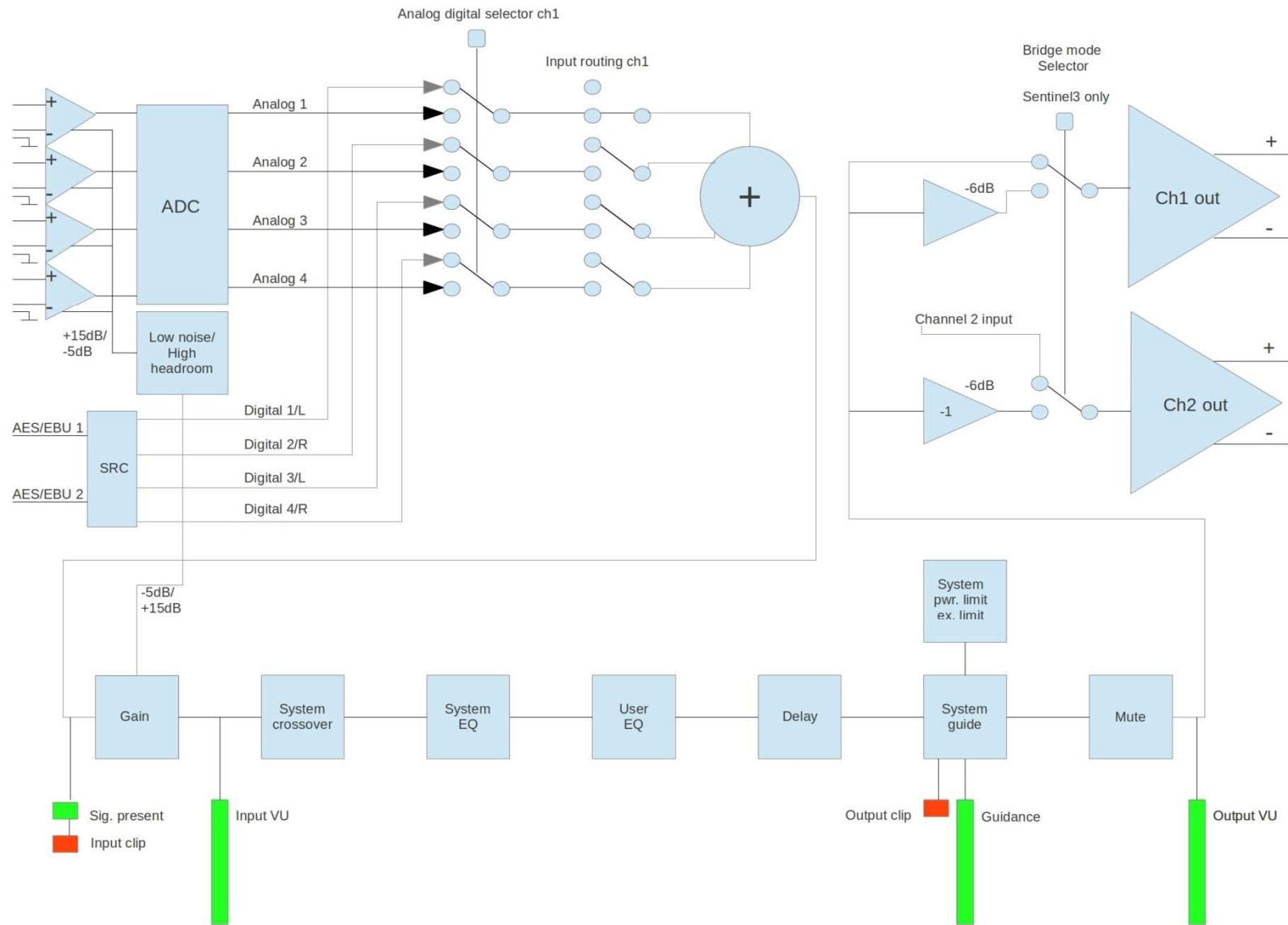

11. Block diagram Bridge mode

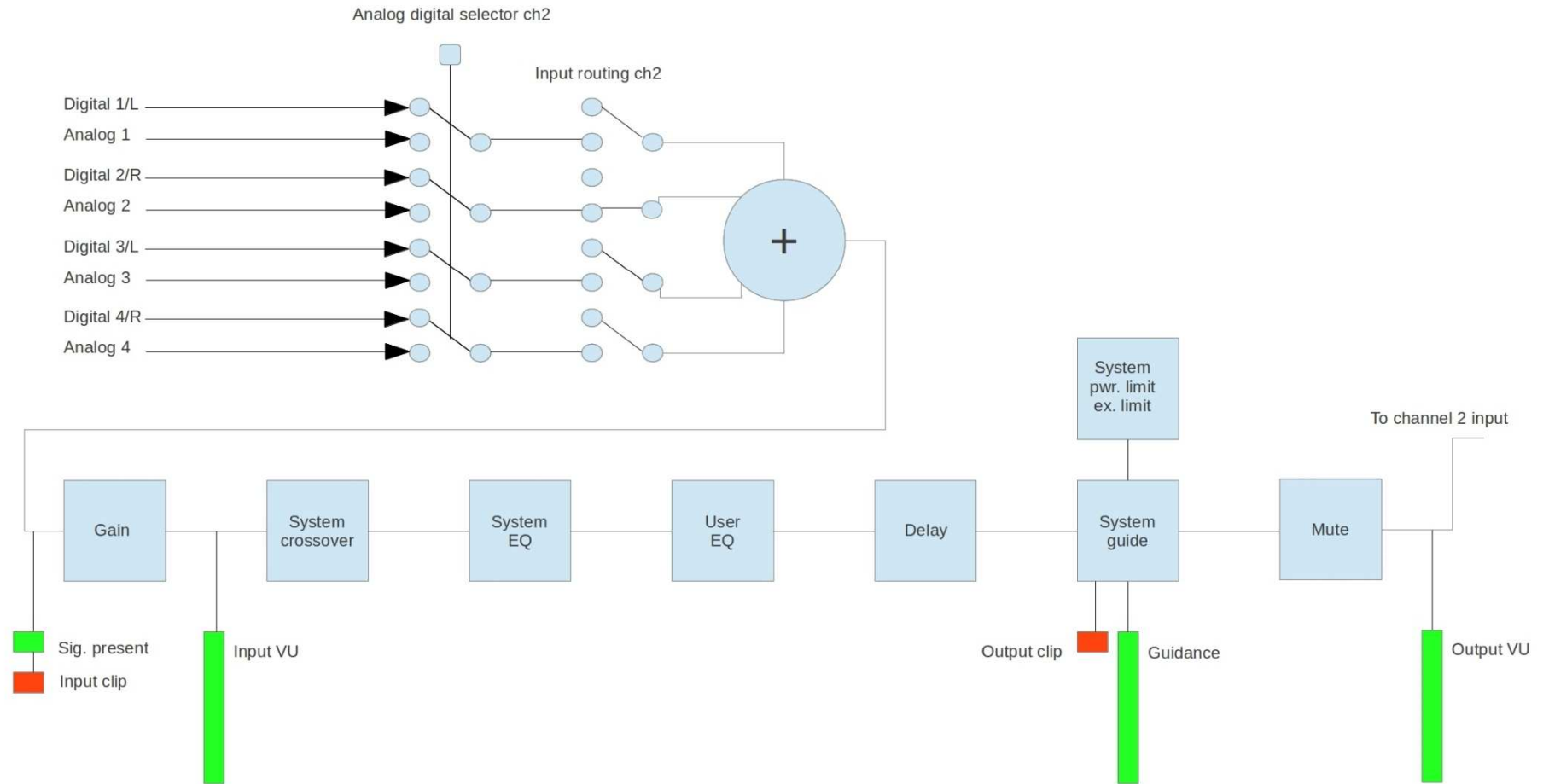

11. EC declaration of conformity

Alcons Audio BV
De Corantijn 69
1689 AN ZWAAG
The Netherlands

States that the following products:

ALC Sentinel 3
ALC Sentinel 10

Are in conformity with the provisions of:

Low Voltage Directive, 2006/95/EC
Electro-Magnetic Compatibility Directive, 2004/108/EC

Applied rules and standards:

EN60065 (Electrical Safety)
EN55103-1 (Emission)
EN55103-2 (Immunity)

Established at Zwaag, the Netherlands,
July 1st, 2014



T.H. Back
Managing Director



Notes

